

CHEVY TRUCKS  LIKE A ROCK

SILVERADO



SILVERADO. THE TRUCK. FROM CHEVROLET.

For nearly 85 years, Chevy Trucks have been on the road — working hard and getting the job done right. It's one reason generations of Americans continue to count on them every day.

There's tremendous pride in that. And incredible responsibility. That's why we've put everything we've learned and everything we know about building pickups into the 2002 Silverado model

lineup. Powerful Vortec and Duramax Diesel engines. Massive towing capacities. Durable components. Smart features. Spacious, well-appointed interiors. Exactly what you've come to

expect from Silverado. The Truck. From Chevrolet — the most dependable, longest-lasting trucks on the road.*

*Dependability based on longevity: 1981–July 2000 full-line light-duty truck company registrations. Excludes other GM divisions.



Throughout this brochure, you'll find invitations to learn more about Silverado's features by visiting chevy.com/silveradobrochure

IT'S NOT JUST ANY TRUCK. IT'S THE RIGHT TRUCK.

It's not enough to do the job — you have to do the job right. That means having a pickup that fits your needs. Silverado offers a wide range of light- and heavy-duty models, cab configurations, box lengths, trim levels, engine choices, and two-wheel-drive and 4x4 capability to meet almost any challenge. And for work, play or anything in between, Silverado 1500HD Crew Cab completes this already formidable lineup. Bottom line: Chevy Silverado has a model that's right for you.

◀ Lots of models. Lots more information. Visit chevy.com/silveradobrochure for a complete rundown.



POWER. A strong Vortec engine is standard in every Chevy Silverado, including the 300-horsepower Vortec 6000 V8 SFI engine in 1500HD, 2500, 2500HD and 3500 models. Page 6.

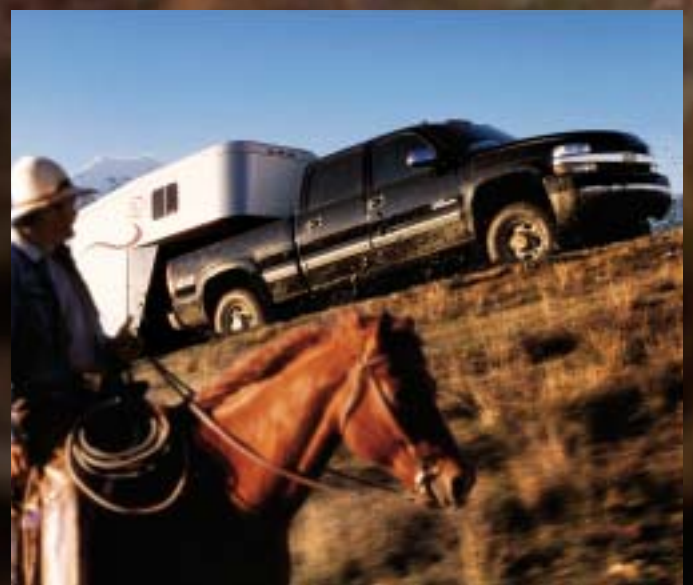

TRAILERING. Whichever model you choose, Chevy Silverado has the strength and trailering features you need to take on the big towing and hauling jobs. Page 14.



SMART FEATURES. Top to bottom, inside and out, Chevy Silverado has components that continue to make it the smartest full-size pickup in Chevrolet history. Page 20.



SILVERADO MODELS. The reasons for driving a pickup are as varied as the people who buy them. So we made sure Silverado could be built to match about any need. Page 26.

THE ULTIMATE POWER TRIP.

Silverado engines give you the confidence to handle tough terrain. The Vortec 6000 V8 SFI engine standard in Silverado 1500HD, 2500, 2500HD and 3500 models is more powerful than the standard engines in heavy-duty Ford and Dodge pickups. An available Big Block Vortec 8100 V8 SFI engine produces more horsepower and torque than V10 engines from Ford and Dodge, too. And the Duramax Diesel 6600 V8 engine* available in Silverado HD models outmuscles diesel engines in F-Series and Ram Pickups.† Chevy Silverado.

It's all about the power.

All claims based on 2001 model year GM Large Pickup segment competitive information. *Limited availability. See your Chevrolet dealer for details.
†Based on horsepower.

Silverado has a powerful story to tell. Read it at chevy.com/silveradobrochure



FOLLOW THE LEADER.

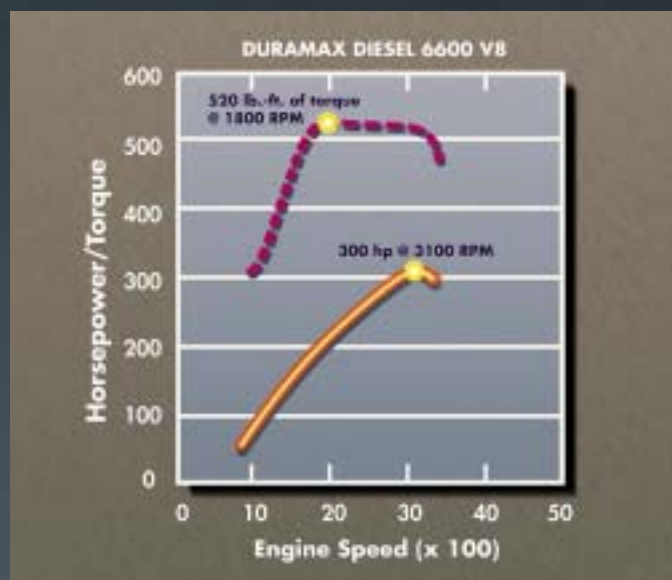

IMPRESSIVE HORSEPOWER AND TORQUE. The available Duramax Diesel 6600 V8 engine has the horsepower and torque to handle the tough jobs. At the same time, it's quieter than diesel engines from Ford and Dodge.



STAYING POWER. Silverado 2500HD and 3500 models powered by the available Duramax Diesel have the strength to get the big loads moving and keep them moving, whether you're traveling along the highway or forging your way up an imposing mountain pass.

DURAMAX DIESEL

When it came time to choose a diesel for Silverado 2500HD and 3500 models, only a truly great engine would do. Here are a few reasons why the available Duramax Diesel 6600 V8 engine* has the full-size pickup world talking:

- Common rail fuel injection, developed by Bosch, optimizes fuel injection rates for reduced combustion noise.
- Direct injection with pilot injection delivers precise amounts of fuel to each cylinder to help reduce emissions and noise levels.
- Fracture-split alloy connecting rods reduce weight and increase durability.
- An integral engine oil cooler optimizes water flow through the oil cooler, providing cooler oil to the engine throughout the operating range.
- The cylinder heads are constructed of strong, lightweight aluminum, which dissipates heat.

*Limited availability. See your Chevrolet dealer for details.



ALLISON 1000 SERIES TRANSMISSION. The 1000 Series transmission is available in Silverado 2500HD and 3500 models equipped with the Duramax Diesel 6600 V8 engine or Big Block Vortec 8100 V8 engine. Silverado 3500 Chassis Cab models with the Allison transmission provide Power Takeoff (PTO) capability to power auxiliary equipment. (Some optional equipment is required for PTO installation.)

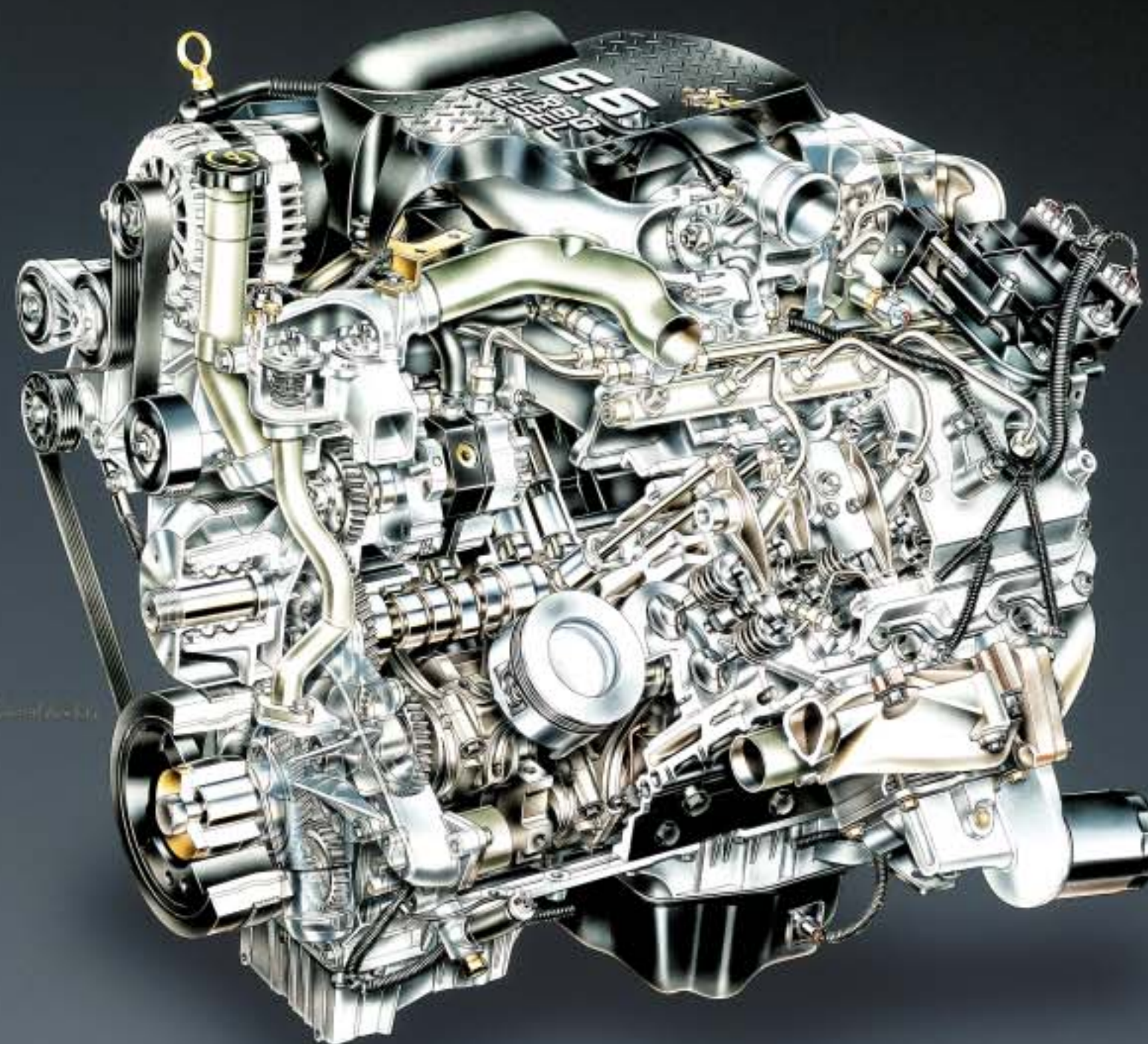

For an in-depth look at the power of the Duramax Diesel engine, visit chevy.com/silveradobrochure

BIG JOBS. BIG VORTEC ENGINES.

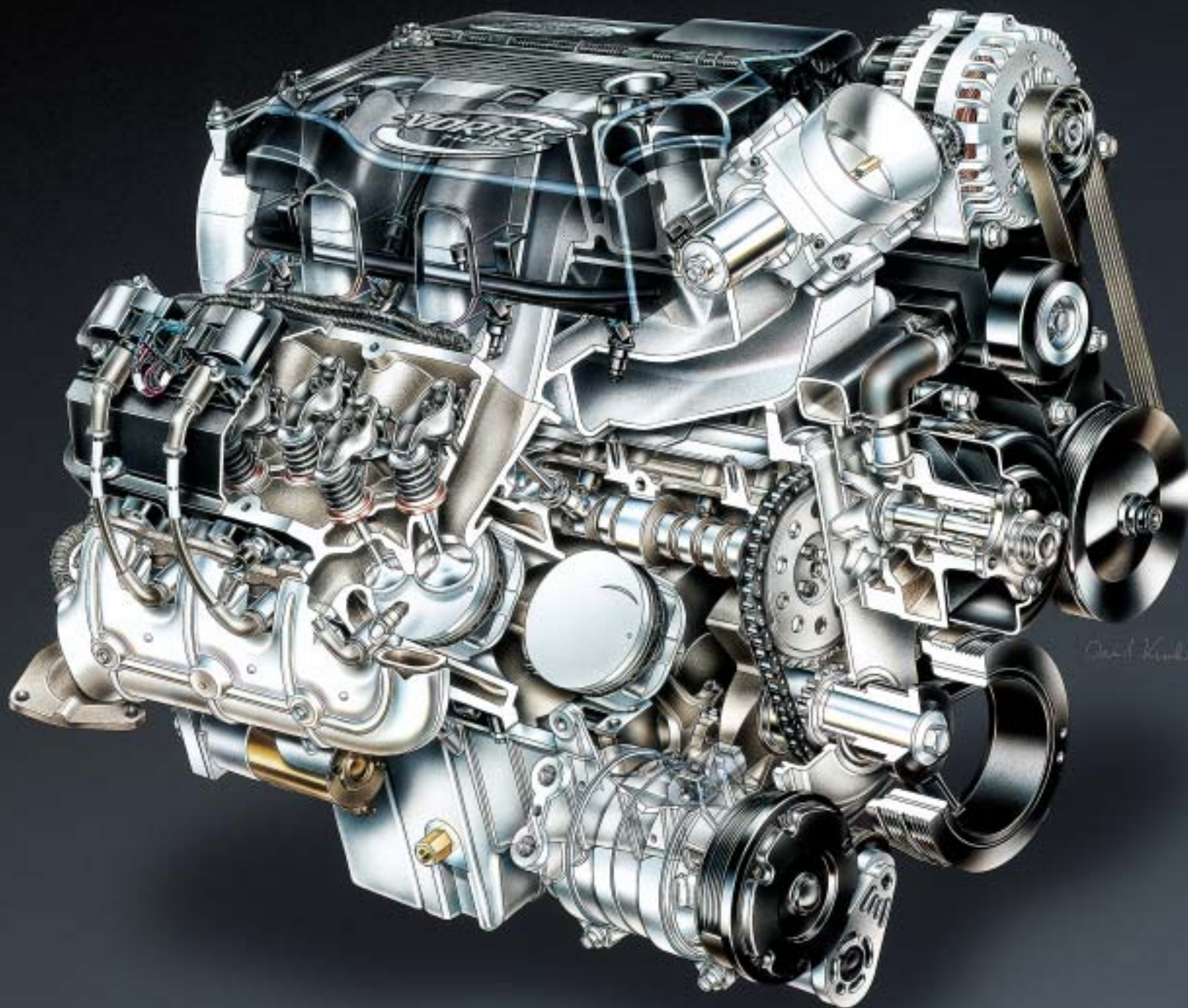

In some cases, only the available Big Block Vortec 8100 V8 SFI engine can do the job. Here are a few reasons why this big engine is such a big story: ■ Coolant loss protection feature allows the engine to be driven a limited distance at a reduced speed to help the driver reach a service facility. ■ High-capacity crankshaft is internally balanced which, in turn, reduces stress on the crankshaft. ■ Efficient seals used in combination with large, flat surfaces are designed to help minimize the chance of oil leaks. ■ Equal-length runners in the intake manifold help provide efficient combustion. ■ Stainless-steel exhaust manifolds. ■ Accessory drive belts designed to operate up to 150,000 miles before replacement.*

*Maintenance needs vary with different uses and driving conditions. See the Owner's Manual for more information.

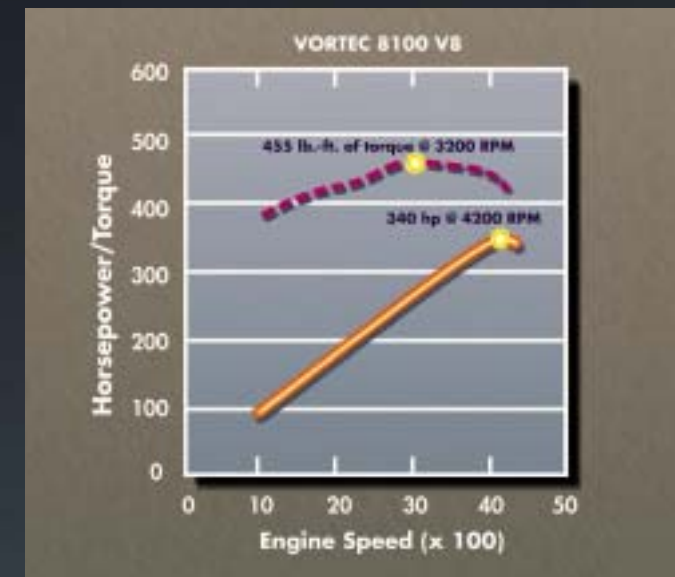

REMARKABLE OUTPUT. In generating 340 horsepower and 455 lb.-ft. of torque, the available Big Block Vortec 8100 V8 engine has more horsepower and torque than V10 engines from Ford and Dodge* and provides confident performance when your truck is pulling heavy loads.

*Based on 2001 model year GM Large Pickup segment competitive information.

The big engines in Silverado tell a big story. Read it at chevy.com/silveradobrochure



VORTEC 6000 V8 SFI ENGINE. As the standard powerplant for Chevy Silverado 1500HD, 2500, 2500HD and 3500 models, this engine produces 300 horsepower at 4400 rpm and 360 lb.-ft. of torque at 4000 rpm and is more powerful than the standard engines in heavy-duty Ford and Dodge pickups.*

*Based on 2001 model year GM Large Pickup segment competitive information.



ZF SIX-SPEED MANUAL TRANSMISSION. This transmission is included with the available Big Block Vortec 8100 V8 SFI and Duramax Diesel 6000 V8 engines and features a "creeper" gear designed to get heavy loads moving. In 3500 Chassis Cab models, it provides PTO capability for powering auxiliary equipment. (Some optional equipment is required for PTO installation.)

A POWERFUL TRADITION.

Each Silverado Vortec engine is designed with the dependable power and strength you expect from a Chevy Truck. Here are a few other features they have in common:

- Sequential Fuel Injection (SFI) for optimum combustion.
- Platinum-tip spark plugs that can travel up to 100,000 miles before they're scheduled to be replaced.*
- Engine coolant that won't require replacement for up to five years or 150,000 miles (whichever comes first).*

*Maintenance needs vary with different uses and driving conditions. See the Owner's Manual for more information.



POWER TRIO. A standard Vortec engine powers every Chevy Silverado, and a Duramax Diesel 6600 V8 engine is available on Silverado 2500HD and 3500 models.



MODELS		ENGINES	TRANSMISSIONS	
		Horsepower @ RPM Torque (lb.-ft.) @ RPM		
STANDARD Silverado 1500 Regular Cab Silverado 1500 2WD Extended Cab Short Box*		Vortec 4300 V6 200 @ 4600 260 @ 2800	STANDARD New Venture Gear 3500 5-Speed Manual†	OPTIONAL 4L60-E Hydra-matic 4-Speed Automatic
STANDARD Silverado 1500 4x4 Extended Cab Short Box*	OPTIONAL Silverado 1500 Regular Cab Silverado 1500 2WD Extended Cab Short Box*	Vortec 4800 V8 270 @ 5200 285 @ 4000	STANDARD New Venture Gear 3500 5-Speed Manual†	OPTIONAL 4L60-E Hydra-matic 4-Speed Automatic
STANDARD Silverado 1500 2WD and 4x4 Extended Cab Long Box	OPTIONAL Silverado 1500 Regular Cab Silverado 1500 Extended Cab Short Box*	Vortec 5300 V8 285 @ 5200 325 @ 4000	STANDARD 4L60-E Hydra-matic 4-Speed Automatic	
STANDARD Silverado 1500HD Silverado 2500 Silverado 2500HD Silverado 3500		Vortec 6000 V8 300 @ 4400 360 @ 4000	STANDARD New Venture Gear 4500 5-Speed Manual**	OPTIONAL 4L80-E 4-Speed Automatic
	OPTIONAL Silverado 2500HD Silverado 3500	Vortec 8100 V8 340 @ 4200 455 @ 3200	STANDARD ZF S6-650 6-Speed Manual**	OPTIONAL Allison 1000 Series 5-Speed Automatic
	OPTIONAL Silverado 2500HD Silverado 3500	Duramax Diesel 6600 V8 300 @ 3100 520 @ 1800	STANDARD ZF S6-650 6-Speed Manual**	OPTIONAL Allison 1000 Series 5-Speed Automatic

*Vortec 5300 V8 SFI engine is standard with LT trim. †Automatic transmission is standard on Extended Cab. **Automatic transmission is standard with LT trim and on 1500HD Crew Cab.

GCWR* — AUTOMATIC TRANSMISSION										
GCWR (LBS.)	9000	9500	10,000	11,000	12,000	13,000	14,000	16,000	20,000	22,000
ENGINE	REAR AXLE RATIO									
Vortec 4300 V6 SFI	3.08	3.42	3.73							
Vortec 4800 V8 SFI				3.42	3.73	4.10				
Vortec 5300 V8 SFI					3.42	3.73	4.10			
Vortec 6000 V8 SFI							3.73	4.10		
Vortec 8100 V8 SFI									3.73	4.10
Duramax Diesel 6600 V8										3.73

GCWR* — MANUAL TRANSMISSION										
GCWR (LBS.)	8000	8500	9000	10,000	11,000	14,000	16,000	22,000		
ENGINE	REAR AXLE RATIO									
Vortec 4300 V6 SFI	3.08	3.42	3.73							
Vortec 4800 V8 SFI			3.42	3.73	4.10					
Vortec 6000 V8 SFI						3.73	4.10			
Vortec 8100 V8 SFI										4.10
Duramax Diesel 6600 V8										3.73

*Gross Combination Weight Rating.

Learn more about the powerful Vortec engines. Visit chevy.com/silveradobrochure

The Vortec 5300 V8 SFI engine generates 285 horsepower and 325 lb.-ft. of torque.

HD LOADS NEED AN HD TRUCK.



Read the full HD story at
chevy.com/silveradobrochure

When you're towing a big load, you're in for the long haul. That's the same commitment you can expect from The Truck. The available Big Block Vortec 8100 V8 SFI and Duramax Diesel 6600 V8* engines provide all the power and endurance you'll need. In fact, Silverado 2500HD and 3500 models have the greatest maximum towing capacity in their class.† And the available Allison 1000 Series five-speed automatic transmission is designed to manage all the torque these engines produce. Towing is heavy-duty business. It's good to have a partner that can hold up its end.

*Limited availability. See your Chevrolet dealer for details.
 †When properly equipped. Based on 2001 model year GM Large Pickup segment competitive information. Excludes other GM vehicles.

A GRADE ABOVE.

When you select the available Allison 1000 Series five-speed automatic transmission, you can tow with added confidence. The Allison 1000 Series includes grade braking that automatically downshifts to help slow the vehicle when the driver applies the brakes while descending long, steep grades. Here are a few other features that make Silverado 2500HD and 3500 great choices for trailering: ■ Available ZF high-capacity six-speed manual transmission (with Duramax Diesel and Vortec 8100 V8 engines). ■ Four-wheel ABS disc brakes with Dynamic Rear Proportioning. ■ Available Duramax Diesel 6600 V8* engine with 520 lb.-ft. of torque. ■ Available Big Block Vortec 8100 V8 SFI engine with 455 lb.-ft. of torque. ■ Available Allison 1000 Series five-speed automatic transmission. ■ Available Heavy-Duty Trailering Package.

*Limited availability. See your Chevrolet dealer for details.



TRAILERING BRAKE PRE-WIRING. In Silverado, you don't have to splice wires to hook up your trailer's electric brakes. Silverado has an Electronic Brake Controller (EBC) connector that's conveniently located under the dash.



TOW/HAUL MODE. This feature enhances the performance of Silverado while pulling a trailer or hauling heavy loads. When activated, it reprograms the automatic transmission shift schedule and helps reduce throttle pedal activity by the driver.



AUTOMATIC TRANSMISSION FLUID TEMPERATURE GAUGE. Equip your Silverado 1500HD, 2500, 2500HD or 3500 model with an automatic transmission and the Heavy-Duty Trailering Package and you'll get an automatic transmission fluid temperature gauge.

Get the complete Silverado towing story by visiting chevy.com/silveradobrochure

UNDERNEATH IT ALL: ONE TOUGH CHEVY TRUCK.

BUSSED ELECTRICAL CENTERS. Silverado has four busbed electrical centers (BECs) that simplify the truck's electrical system to help achieve greater reliability.

TOW/HAUL MODE. When activated, Tow/Haul mode enhances trailering by reprogramming the automatic transmission shift schedule when you're transporting heavy loads.

HEAVY-DUTY TRANSMISSIONS. No matter which powerful engine you choose for your Chevy Silverado HD, you can feel confident knowing the transmission has been designed with heavy-duty applications in mind.

CORROSION RESISTANCE. All body panels (except the roof) are constructed from two-sided galvanized steel for added corrosion resistance, and wax is applied to the frame to help resist corrosion.

STAMPED REAR FRAME. The rear C-section of Silverado's frame is stamped, providing the strength Chevy Truck owners expect.

COMPOSITE REAR FENDERS. Rear fenders on Silverado 3500 Big Dooley models are constructed from a one-piece injection-molded material that resists minor dings and scratches and will never rust.

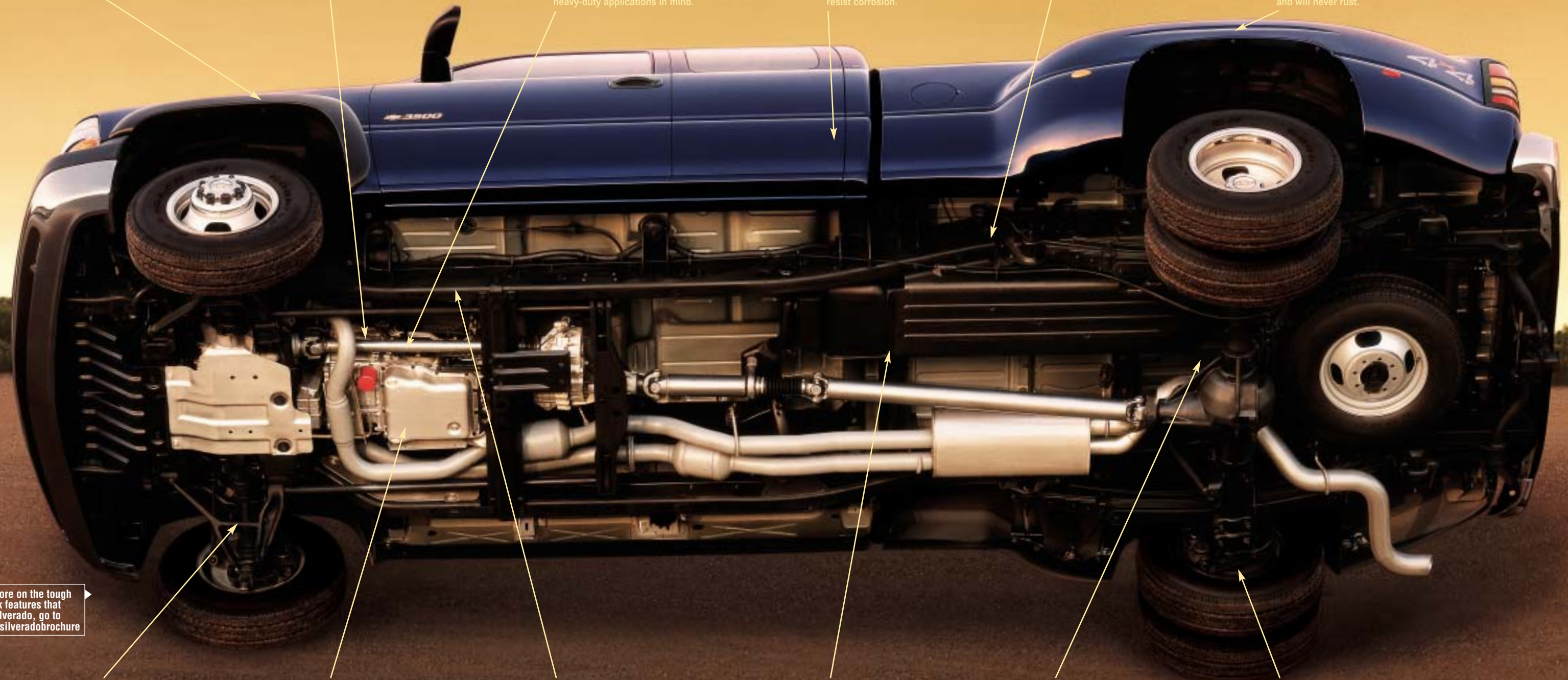

For even more on the tough Chevy Truck features that make up Silverado, go to chevy.com/silveradobrochure

FRONT SUSPENSION DESIGN. Chevy Silverado 1500HD, 2500, 2500HD and 3500 models have an independent front suspension design that incorporates durable torsion bars and strong, weight-saving control arms. This design provides impressive payload capacities.

POWER TAKEOFF (PTO) CAPABILITY. 3500 Chassis Cab models equipped with the standard ZF six-speed manual transmission or available Allison five-speed automatic transmission include PTO capability. PTOs can power auxiliary equipment. (Some optional equipment is required for PTO installation.)

HYDROFORMED FRONT FRAME. Hydroforming the front section of the frame during manufacturing reduces the stretching of the steel. This allows the steel to retain more of its strength, making the Silverado frame exceptionally durable.

HYDROFORMED CROSS MEMBERS. Hydroformed tubular cross members and close-out plates provide enhanced torsional performance.

DYNAMIC REAR PROPORTIONING (DRP). Standard four-wheel antilock disc brakes include DRP, which recognizes rear-brake lockup and regulates the pressure applied to the rear brakes.

FOUR-WHEEL ANTILOCK DISC BRAKES. No matter which Silverado you choose, four-wheel antilock disc brakes are standard and are designed to help you keep in control by reducing wheel lockup while braking hard on most slippery surfaces.

THE BRAINS BEHIND THE BRAWN.

AUTOMATIC HEADLAMPS. The headlamps and taillamps on Chevy Silverado turn on automatically whenever it senses low-light or nighttime driving conditions.

See even more of Chevy Silverado's smart features at chevy.com/silveradobrochure

BATTERY-RUNDOWN PROTECTION. Battery-rundown protection automatically turns off your lights and underhood lamp 20 minutes after the ignition has been turned off.

AUTOTRAC 4x4. Available in select light-duty 1500, 1500HD and 2500 models, the Autotrac transfer case lets you engage AUTO 4WD on the 4x4 system — so you don't have to worry about having four-wheel-drive capability when you need it. That's because power is automatically transferred between the front and rear wheels whenever rear-wheel slippage is detected. You just set it, then forget it.

DRIVER MESSAGE CENTER. This feature keeps you informed on up to 17 functions (depending on options) of your truck's key operating systems. It even lets you know when you're low on windshield washer fluid.

ENGINE HOUR METER. An engine hour meter is standard and indicates how long your engine has been in use. You'll appreciate this feature, especially if your truck spends a lot of time idling.

DRIVER LOCKOUT PROTECTION. To protect you from locking your truck keys in the vehicle, this feature stops the power door locks from locking when the key is in the ignition and a door is open. If the power door lock switch is pressed, all of the doors will lock — and then the driver's door will immediately unlock when the door is closed.

TOW/HAUL MODE. This useful feature enhances the performance of Chevy Silverado while pulling a trailer or hauling heavy loads. When activated, it reprograms the automatic transmission shift schedule and helps reduce throttle pedal activity by the driver.

AIR BAG OFF SWITCH.* Silverado has a passenger-side Air Bag Off Switch for use when carrying children.†

*Not included in Crew Cab models.

†A NOTE ON CHILD SAFETY: Always use safety belts and proper child restraints, even with air bags. Children are safer when properly secured in a rear seat. Never place a rear-facing infant restraint in the front seat of any vehicle equipped with an active air bag. See your vehicle Owner's Manual and child safety seat instructions for more safety information.

PRO-TEC. THE NEXT STEP IN DURABILITY.

CARGO LAMP. A cargo lamp lets you check on the contents in the bed of your Silverado without having to turn on interior dome (or other exterior) lights.

STAKE POCKETS. The cargo box on Silverado has integrated stake pockets that can accommodate 1" x 2" stakes to increase the height of the box.

TWO-TIER LOADING. For added convenience, pocket shelves are molded into the upper pickup box walls to allow for two distinct levels of loading.

Chevy Silverado takes another step toward long-lasting dependability with the available PRO-TEC pickup box and tailgate. Available on Silverado 1500 2WD and 4x4 Extended Cab Short Box models and 2500 4x4 Extended Cab Short Box models, the PRO-TEC box and tailgate are constructed from an injection-molded composite material that resists scratches and dents and will never rust. In addition to this rugged durability, the great-looking PRO-TEC box is lighter than its steel counterpart. Are these the only benefits of the PRO-TEC box and tailgate? Let's just say we haven't even scratched the surface.



PRO-TEC TAILGATE. The PRO-TEC tailgate is lighter than its steel counterpart, so in addition to resisting scratches and dents, it allows for easier opening and closing.

BULKHEAD DIVIDERS. When you insert a piece of lumber into the front side panels, the front of the pickup box is protected from shifting loads.

TAILGATE PROTECTOR. A tailgate protector helps prevent chipping when you're carrying long 2x4s or ladders.

REAR STEP-BUMPER. A strong rear step-bumper on Silverado has a full protective step pad. It's rated at 600 lbs. tongue weight and 5,000 lbs. trailer weight. (Your pickup truck's trailering capacity may be less, based upon powertrain combination selected.)

TIE-DOWN BRACKETS. Built-in tie-down brackets near all four corners help secure large loads that are likely to move.

Check out more features of the available PRO-TEC box and tailgate at chevy.com/silveradobrochure

ROUND UP THE WORKHORSES.

Every Chevy Silverado is an original, with the strength and power to satisfy the individual in you. With numerous body styles, trim levels and configurations, you can build one to meet your specifications. For an in-depth look at all the Silverado Pickups, see the Model Selectors on pages 48-51.

*Silverado 1500 LS
2WD Sportside Regular
Cab in Victory Red with
available features.*



*Silverado 1500 Base 2WD
Regular Cab Long Box in
Forest Green Metallic.*



*Silverado 3500 Base 2WD
Regular Cab Chassis Cab
in Summit White with stake
body from an independent
supplier. See page 46 for
a note about alterations
and warranties.*



*Silverado 1500HD LT 4x4
Crew Cab Short Box in
Light Pewter Metallic.*



*Silverado 2500HD LS 4x4
Extended Cab Long Box in
Indigo Blue Metallic with
available features.*



*Silverado 3500 LS
4x4 Regular Cab Big Dooley
Long Box in Onyx Black with
available features.*

Take a closer look at the entire Silverado lineup at chevy.com/silveradobrochure

ALWAYS DEPENDABLE. ALWAYS THERE.

The bond between Chevy Truck owners and their Silverado Pickups is a powerful thing. That has a lot to do with the long-lasting dependability of Chevy Trucks and their ability to handle almost any task. Silverado 1500 LT has everything you'd expect from a Chevy Truck, including these key features: ■ Vortec 5300 V8 SFI engine with 285 horsepower and 325 lb.-ft. of torque. ■ 2WD and 4x4 configurations. ■ Four-speed automatic overdrive transmission. ■ Four-wheel antilock disc brakes. ■ Fourth door standard. ■ Body-side moldings with chrome accents. ■ Deluxe chrome grille. ■ Foglamps.



To learn more about some of the features of the 1500 LT Extended Cab with the Z71 option, go to chevy.com/silveradobrochure

FIRST-CLASS ACCOMMODATIONS.

When you're inside Silverado LT Extended Cab, you've got the best seat in the house. It has more rear-seat legroom than comparable Ford and Toyota pickups* and is filled with features you might find on some upscale sport utility vehicles. Like Custom Leather seating surfaces. OnStar.† Even an AM/FM stereo with both CD and cassette players. In Silverado LT, the focus is on luxury.

*Based on 2001 model year GM Large Pickup segment competitive information.
†One-year OnStar Safety and Security service contract is standard on Silverado LT. Call 1-800-ONSTAR-7 for system limitations and details.

See other features of this first-class LT interior at chevy.com/silveradobrochure

WIDE-OPEN SPACES.



For those days when you need to get out of the city and into a different frame of mind, Silverado LT Extended Cab lets you take to the road in style, thanks to these standard features: ■ More rear-seat headroom and legroom than comparable Ford and Toyota pickups.* ■ OnStar.† ■ Heated eight-way power front seats with Custom Leather seating surfaces. ■ AM/FM stereo with cassette and CD players, and auto tone control. ■ Self-dimming inside rearview mirror with eight-point compass and temperature gauge. ■ Remote Keyless Entry with a content theft alarm. ■ Cruise control. ■ Power windows and door locks. ■ Rear-seat heat ducts. ■ Driver Message Center. ■ Tilt-Wheel steering column. ■ PASSlock theft-deterrent system. ■ Rear-window defogger. ■ Leather-wrapped steering wheel. ■ Air conditioning. ■ Center console with two cup holders and a storage area.



ONSTAR.† This feature is standard in Chevy Silverado LT models and includes a one-year Safety and Security plan for air bag notification, emergency and roadside services, theft tracking, remote door unlock and Accident Assist.

*Based on 2001 model year GM Large Pickup segment competitive information.
†One-year OnStar Safety and Security service contract is standard on Silverado LT. Call 1-800-ONSTAR-7 for system limitations and details.



HEATED OUTSIDE MIRRORS. Foldaway, electric heated outside mirrors help keep your rear view clear in inclement weather. They turn on when you push the rear-window defogger button.



HEATED EIGHT-WAY POWER SEATS. Silverado LT has standard heated front bucket seats with Custom Leather seating surfaces. The seats feature eight-way power, power recline, lumbar and seatback bolster.

Check out the LT interior at chevy.com/silveradobrochure

STRONGER THAN SADDLE LEATHER.

For your toughest jobs, count on Silverado 2500HD to pull you through. 2500HD models have the strength and capability you can depend on, as well as the following features: ■ Vortec 6000 V8 SFI engine with 300 horsepower and 360 lb.-ft. of torque. ■ Designed with a hydroformed front frame and independent front torsion bar suspension. ■ 2WD and 4x4 configurations. ■ Five-speed manual OD transmission. ■ Four-wheel antilock disc brakes with DRP. ■ GVWRs* of 9,200 lbs. ■ Available Big Block Vortec 8100 V8 SFI or Duramax Diesel 6600 V8† engine. ■ Available Allison 1000 Series five-speed automatic transmission or ZF six-speed manual transmission.

*Gross Vehicle Weight Rating. When properly equipped; includes weight of vehicle, passengers, cargo and equipment. †Limited availability. See your Chevrolet dealer for details.

Find out how strong Silverado 2500HD LS Crew Cab is at chevy.com/silveradobrochure

IT'S BIG ON COMFORT.

Silverado 2500HD LS Crew Cab has some big ideas when it comes to interiors. The Crew Cab provides Custom Cloth seating for up to six, four full-size doors and more rear-seat legroom than is found in Silverado Extended Cab models. In fact, there's enough space for a family or work crew to really stretch out. And that's the kind of thing that puts everyone in a comfort zone.



Read the whole Silverado LS Crew Cab interior story at chevy.com/silveradobrochure

FAMILY ROOM FOR YOUR CREW.



For more on LS Crew Cab's full-size features, visit chevy.com/silveradobrochure

Traveling is easy in Silverado LS Crew Cab — not to mention entering and exiting — due to its four full-size doors. And this roomy Silverado has these select standard features: ■ Air conditioning. ■ Power windows and door locks. ■ Cruise control. ■ AM/FM stereo with a CD player and auto tone control. ■ Rear-seat heat ducts. ■ Tilt-Wheel steering column. ■ PASSlock theft-deterrent system. ■ Driver Message Center. ■ Leather-wrapped steering wheel. ■ Solar-Ray tinted glass. ■ Center storage armrest.



AUDIO SYSTEM. Standard on Silverado LS models is an AM/FM stereo with compact disc player and auto tone control.



CUSTOM LEATHER SEATING SURFACES. Silverado LS Crew Cab can be equipped with available front-seat Custom Leather seating surfaces. The reclining front bucket seats have six-way power for added convenience.



REMOTE KEYLESS ENTRY. The system includes power door locks and lets you lock and unlock the doors and turn on the interior lights from up to 30 feet away.

BIG DOOLEY MUSCLE.

At the job site, there are a few things you can count on. Long days. Hard work. And the strength of Silverado 3500. This powerful performer has these select features:

- Vortec 6000 V8 SFI engine. ■ Available Big Block Vortec 8100 V8 SFI engine or Duramax Diesel 6600 V8 engine.*
- Available Allison 1000 Series five-speed automatic transmission or ZF six-speed manual transmission.
- GCWR up to 22,000 lbs. ■ Trailering capacity up to 15,800 lbs.† using an available fifth-wheel hitch.
- Hydroformed front frame section. ■ Stamped rear frame. ■ Independent front torsion bar suspension.

*Limited availability. See your Chevrolet dealer for details. †When properly equipped. Maximum trailer weight ratings are calculated assuming a base vehicle, except for any option(s) necessary to achieve the rating, plus driver. The weight of other optional equipment, passengers and cargo will reduce the maximum trailer weight your vehicle can tow. See your Chevy Truck dealer for additional details.

Get all the information on 3500 Base Regular Cab Big Dooley at chevy.com/silveradobrochure

THE STANDARD.



Inside and out, Silverado Base has a lot to offer. See it at chevy.com/silveradobrochure



At its heart, Silverado Base Regular Cab is one hard worker. That's because every Chevy Silverado Base model starts with Chevy Truck toughness. Add in these following standard features and you'll have the confidence you need to make Silverado your base of operations: ■ 200-horsepower Vortec 4300 V6 SFI engine. ■ Four-wheel disc ABS. ■ Five-speed manual overdrive transmission. ■ Tilt-Wheel steering column. ■ Driver Message Center. ■ PASSlock theft-deterrent system. ■ Dual power ports. ■ Reclining driver and passenger seats. ■ Intermittent windshield wipers. ■ Full gauges with tachometer, trip odometer and engine hour meter. ■ Solar-Ray tinted glass.



FOUR-WHEEL DISC ABS. No matter which Silverado you choose, four-wheel antilock disc brakes are standard and are designed to help keep you in control by reducing wheel lockup while braking hard on most slippery surfaces.

GUARANTEED TO STOP TRAFFIC.

The Silverado 1500 LS 4x4 Extended Cab Short Box in Victory Red is equipped with the optional Z71 Off-Road Package. Chrome brush guard, chrome tubular side steps, vent visors and soft tonneau cover are from GM Accessories. See your Chevy Truck dealer for more details. And for more information on Silverado racing, visit chevy.com/motorsports/silverado

There are even more GM Accessories for Silverado. See them at chevy.com/silveradobrochure

GM Accessories let you add even more distinction to your Silverado. These are features that look good and work hard. And all GM Accessories installed by your Chevy dealer are covered under the GM New Vehicle Limited Warranty.* ■ Molded splash guards. ■ Fifth-wheel trailer hitch. ■ Tonneau covers, soft and hard. ■ Bed rails. ■ Bed rail protector. ■ Grille brush guard. ■ Running boards. ■ Bed rack system. ■ Bedliner. ■ Bed extender. ■ Tubular side steps. ■ Z71 graphics. ■ Bed tent. ■ Bed mat. ■ 12-disc CD changer. ■ Fender flares. ■ Hitch-mounted ski or bike carrier. ■ Snow Plow Prep Package.

*3 years/36,000 miles (whichever comes first). See your Chevy dealer for details. NOTE: All GM Accessories are optional.



HARD TONNEAU COVER. The hard tonneau cover includes a lock to help keep all your cargo secure. And the cover folds back for easy accessibility.



BOX EXTENDER. A handy brushed aluminum extender lets you expand the hauling capabilities of your Silverado. It swings out over the open tailgate door to provide additional length, and swings in to provide a stable cargo area.



SNOW PLOW PREP PACKAGE. This hardworking package includes a 130-amp alternator, and increased cooling and electrical connections. (Snow plow shown is from Meyer, an independent supplier. See page 46 for a note about alterations and warranties.)

YOU NEVER TRAVEL ALONE.

Chevy Trucks are the most dependable, longest-lasting trucks on the road* — sold and serviced by the largest dealer network in the USA. When you buy a Chevy Truck, you also get a rock-solid, comprehensive owner protection plan that will be there for you from the moment you take delivery. The plan includes:

- **New Vehicle Limited Warranty***
- **24-Hour Roadside Assistance**
- **Courtesy Transportation**

It's an owner protection plan you can believe in. Your Chevrolet dealer has all the details.

*Dependability based on longevity: 1981–July 2000 full-line light-duty truck company registrations. Excludes other GM divisions. †3 years/36,000 miles (whichever comes first). See dealer for details.



With the push of a button, available OnStar® service connects you with trained OnStar Advisors. They'll offer valuable assistance for just about any situation — 24 hours a day, seven days a week — providing safety, security and convenience wherever you drive. For more information, call **1-800-ONSTAR-7** (1-800-667-8277) or visit us at onstar.com

*Service will vary depending on truck brand purchased and service plan. OnStar uses existing emergency service providers and cellular and satellite technologies.

24-HOUR ROADSIDE ASSISTANCE

Call **1-800-CHEV-USA** toll free anytime during the warranty period. Towing and basic technical advice come with the Basic Care Package. Courtesy Care provides additional features,* including locksmith services, flat tire changing, fuel delivery, non-warranty towing and jump starts. Some services will incur costs. Chevrolet reserves the right to modify or discontinue Basic Care and Courtesy Care at any time.

*During the term of the New Vehicle Limited Warranty.

NEW VEHICLE LIMITED WARRANTY

This warranty is for GM vehicles registered in the USA. See your Chevrolet dealer for terms and conditions.

Covered for 3 years/36,000 miles (whichever comes first):

- The complete vehicle
- Tires
- Towing to your nearest Chevrolet dealership
- Cosmetic corrosion resulting from defects
- Repairs made to correct any vehicle defect
- No charge for most warranty repairs.

Covered for 6 years/100,000 miles (whichever comes first):

- Rust-through corrosion

FOR MORE INFORMATION ON 2002 CHEVROLET CAR OR TRUCK PRODUCTS, call **1-800-950-2438** or visit us at chevy.com

COURTESY TRANSPORTATION

Ask your participating Chevrolet dealer for Courtesy Transportation if you drop your vehicle off for repairs under the New Vehicle Limited Warranty. Also see if you qualify for expense reimbursement and/or vehicle rental. Services vary at election of participating dealer.

CHEVROLET CUSTOMER ASSISTANCE CENTER

Call **1-800-222-1020** toll free to talk directly to specialists who can handle any product or service concern you may have.

FROM DAY ONE ...

The vehicle is checklist-ready for you to drive away, and a full orientation awaits you on everything about your new Chevy Silverado.

ADDITIONAL INFORMATION

IMPORTANT: A WORD ABOUT THIS BROCHURE We have tried to make this brochure comprehensive and factual. We reserve the right, however, to make changes at any time, without notice, in prices, colors, materials, equipment specifications, models and availability. Since information may have been updated since the time of printing, please check with your Chevrolet dealer for complete details. Chevrolet reserves the right to lengthen or shorten the model year for any product for any reason, or to start and end model years at different times.

RUST-THROUGH CORROSION PROTECTION Chevrolets are designed and built to resist corrosion. All body sheet-metal panels are warranted against rust-through for 6 years/100,000 miles (whichever comes first). Application of additional rust-inhibiting materials is not required and none is recommended. See your Chevrolet dealer for terms of this limited warranty.

SMARTLEASE BY GMAC For information about SmartLease, SmartBuy or any of the other quality GMAC financing options, see your Chevy dealer, call **1-800-32-SMART** or visit our web site at www.gmacfs.com

THE GM MOBILITY PROGRAM Chevrolet recognizes the importance of mobility to everyone's life and, therefore, offers financial assistance to persons with disabilities through the General Motors Mobility Program. This program can provide up to \$1,000 reimbursement toward the cost of eligible aftermarket adaptive equipment for drivers or passengers when installed or reinstalled on any eligible purchased or leased new GM vehicle. For details and free resource information, call **1-800-323-9935** (TTY users: **1-800-833-9935**).

UPDATED SERVICE INFORMATION Chevrolet dealers receive useful service bulletins about Chevrolet products. You can purchase them by calling **1-800-551-4123**.

ASSEMBLY Chevrolets and their components are assembled or produced by different operating units of General Motors, its subsidiaries or suppliers to GM worldwide. We sometimes find it necessary to produce Chevrolets with different or differently sourced components than originally scheduled. Since some options may be unavailable when your vehicle is assembled, we suggest that you verify that your vehicle includes the equipment you ordered or, if there are changes, that they are acceptable to you.

ENGINES Chevrolets are equipped with engines produced by different operating units of GM, its subsidiaries or suppliers to GM worldwide.

GM ACCESSORIES WARRANTY INFORMATION All GM Official Licensed Products purchased from and/or installed by your GM dealer are covered under the individual accessory manufacturers' warranties, and they are not warranted by General Motors or its dealers. Should any such GM Licensed Product require service, please contact the GM Licensed Product manufacturer identified on the product or its accompanying documentation. If the manufacturer is not so identified, contact your GM dealer to obtain the necessary information.

AN IMPORTANT NOTE ABOUT ALTERATIONS AND WARRANTIES Installations or alterations to the original equipment vehicle (or chassis) as distributed by General Motors are not covered by the General Motors New Vehicle Limited Warranty. The special body company, assembler, equipment installer or upfitter is solely responsible for warranties on the body or equipment and any alterations (or any effect of the alterations) to any of the parts, components, systems or assemblies installed by GM. General Motors is not responsible for the safety or quality of design features, materials, or workmanship of any alterations by such a supplier.

GM PROTECTION PLAN The GM Protection Plan® offers mechanical repair protection in addition to that provided by GM's New Vehicle Limited Warranty. Coverage for vehicle maintenance is also available. Ask your dealer about the GM Protection Plan. Coverage available only in the U.S. and Canada.

ACCELERATE YOUR COLLEGE SAVINGS GM — along with many other leading companies — has teamed up with Upromise, the revolutionary college savings accelerator that can help you save thousands of dollars for college. When you purchase or lease an eligible new Chevrolet, GM will contribute \$150 into your Upromise college savings account. For complete details on the GM-Upromise program, go to <http://upromise.gm.com>. Enrollment is simple and absolutely free. To receive the \$150 GM contribution, you need to be a Upromise member 30 days before you take delivery of your vehicle.

General Motors, GM, the GM Emblem, Chevrolet, the Chevrolet Emblem, Astro, Blazer, Chevy Express, S-10, Silverado, Suburban, Tahoe, Tracker, TrailBlazer, Autotrac, Big Dooley, Crew Cab, Hydra-matic, Solar-Ray, PassBlock, Delco, ETR, Z71 and 1-800-CHEV-USA are registered trademarks and Chevy, Allison, Avalanche, Duramax, PRO-TEC and Vortec are trademarks of the General Motors Corporation. TheftLock is a registered trademark of the Delco Electronics Corporation. GMAC, SmartLease and SmartBuy are registered service marks of the General Motors Acceptance Corporation. HomeLink is a registered trademark of Johnson Controls Inc. OnStar is a registered service mark of OnStar Corporation. DEWALT is a registered trademark of DEWALT Tools. ©2001 General Motors Corporation. All rights reserved.

Litho in USA. September 2001



For more information about Chevrolet's participation in the 2002 Olympic Winter Games, visit chevy.com

SILVERADO 1500/2500 DIMENSIONS AND SPECIFICATIONS

MODEL SELECTOR	PICKUP MODEL	TRIM LEVELS	SERIES	DRIVE	WHEELBASE (IN.)	OVERALL LENGTH (IN.)	GVWR ¹ (LBS.)	STANDARD TRANSMISSIONS	OPTIONAL TRANSMISSIONS	PAYLOAD ² BASE MODEL (LBS.)	STANDARD ENGINES	HP @ RPM	TORQUE @ RPM	OPTIONAL ENGINES
	Regular Cab Sportside Box	Base, LS	1500 (1/2-ton)	2WD 4x4	119.0	203.3	6100	5-speed manual overdrive	Hydra-matic 4-speed automatic overdrive	(2WD) 2038 (4x4) 1738	Vortec 4300 V6	200 @ 4600	260 @ 2800	Vortec 4800 V8 Vortec 5300 V8 ³
	Regular Cab Fleetside Short Box	Base, LS	1500 (1/2-ton)	2WD 4x4	119.5	203.3	6100	5-speed manual overdrive	Hydra-matic 4-speed automatic overdrive	(2WD) 2021 (4x4) 1731	Vortec 4300 V6	200 @ 4600	260 @ 2800	Vortec 4800 V8 Vortec 5300 V8 ³
	Regular Cab Fleetside Long Box	Base, LS	1500 (1/2-ton)	2WD 4x4	133.0	222.2	6400	5-speed manual overdrive	Hydra-matic 4-speed automatic overdrive	(2WD) 2192 (4x4) 1886	Vortec 4300 V6	200 @ 4600	260 @ 2800	Vortec 4800 V8 Vortec 5300 V8 ³
				2500 (3/4-ton)	2WD	133.0	222.2	8600	5-speed HD manual overdrive	Hydra-matic 4-speed HD automatic overdrive	(2WD) 3638	Vortec 6000 V8	300 @ 4400	360 @ 4000
	Extended Cab Sportside Box	Base, LS, LT	1500 (1/2-ton)	2WD 4x4	143.5	203.3	(2WD) 6200 (4x4) 6400	Hydra-matic 4-speed automatic overdrive	—	(2WD) 1718 (4x4) 1554	Vortec 4800 V8 ⁴	270 @ 5200	285 @ 4000	Vortec 5300 V8
	Extended Cab Fleetside Short Box	Base, LS, LT	1500 (1/2-ton)	2WD 4x4	143.5	227.8	(2WD) 6200 (4x4) 6400	Hydra-matic 4-speed automatic overdrive	—	(2WD) 1711 (4x4) 1547	(2WD) Vortec 4300 V6 ⁴ (4x4) Vortec 4800 V8 ⁴	200 @ 4600 270 @ 5200	260 @ 2800 285 @ 4000	(2WD) Vortec 4800 V8 (4x4) Vortec 5300 V8 ³
				2500 (3/4-ton)	4x4	143.5	227.8	8600	5-speed HD manual overdrive ⁵	Hydra-matic 4-speed HD automatic overdrive	(4x4) 3152	(4x4) Vortec 6000 V8	300 @ 4400	360 @ 4000
	Extended Cab Fleetside Long Box	Base, LS, LT	1500 (1/2-ton)	2WD 4x4	157.5	246.7	6400	Hydra-matic 4-speed automatic overdrive	—	(2WD) 1675 (4x4) 1377	Vortec 5300 V8	285 @ 5200	325 @ 4000	—
	Crew Cab Fleetside Short Box	LS, LT	1500HD	2WD 4x4	153.0	232.2	8600	Hydra-matic 4-speed automatic overdrive	—	(2WD) 3143 (4x4) 2847	Vortec 6000 V8	300 @ 4400	360 @ 4000	—

¹ Gross Vehicle Weight Rating (GVWR). When properly equipped; includes vehicle, passengers, cargo and equipment. ² Maximum payload capacity includes weight of driver, passengers, optional equipment and cargo. ³ Available only with four-speed automatic overdrive transmission. ⁴ Vortec 5300 V8 is included with LT trim. ⁵ Not available with LT trim.

A
 119.0" Reg. Cab Short Box
 133.0" Reg. Cab Long Box
 143.5" Ext. Cab Short Box
 153.0" Crew Cab Short Box
 157.5" Ext. Cab Long Box

B
 203.3" Reg. Cab Short Box
 222.2" Reg. Cab Long Box
 227.8" Ext. Cab Short Box
 232.2" Crew Cab Short Box
 246.7" Ext. Cab Long Box



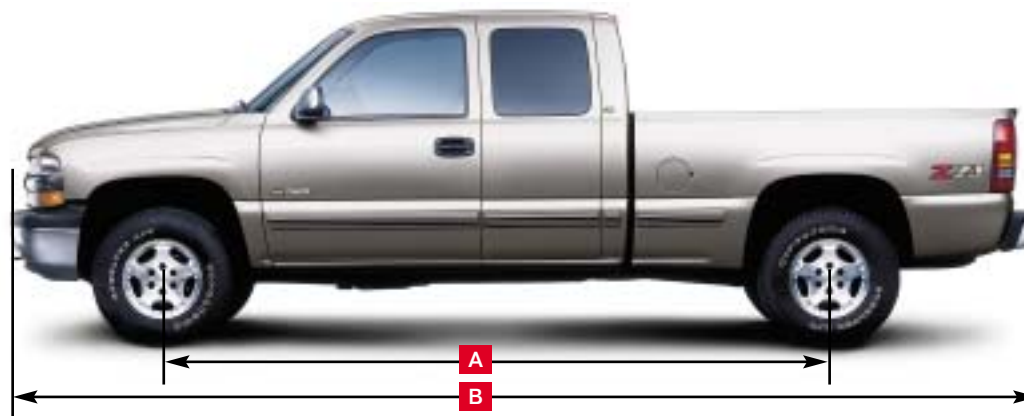

To use the online model configurator, visit chevy.com/silveradobrochure

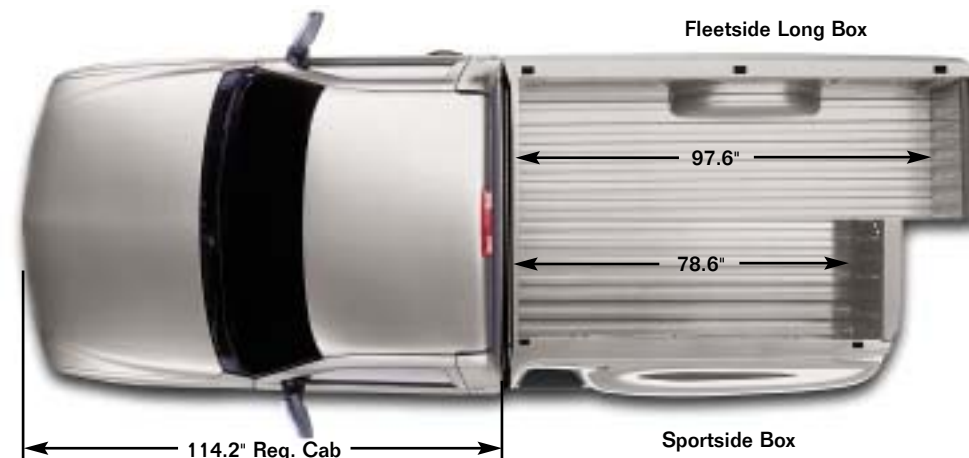
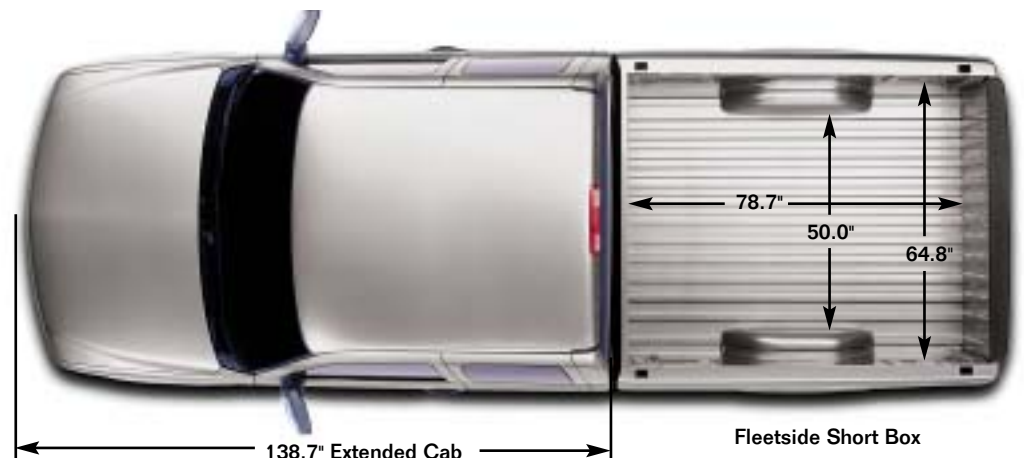

C
 71.0" to 74.5" depending on series, model and tire size selected.



SILVERADO 2500HD/3500 DIMENSIONS AND SPECIFICATIONS

MODEL SELECTOR	PICKUP MODEL	TRIM LEVELS	SERIES	DRIVE	WHEELBASE (IN.)	OVERALL LENGTH (IN.)	GVWR ¹ (LBS.)	STANDARD TRANSMISSIONS	OPTIONAL TRANSMISSIONS	PAYLOAD ² BASE MODEL (LBS.)	STANDARD ENGINES	HP @ RPM	TORQUE @ RPM	OPTIONAL ENGINES
	Regular Cab Fleetside Long Box	Base, LS	2500HD (3/4-ton)	2WD 4x4	133.0	222.2	9200	5-speed HD manual overdrive	Hydra-matic 4-speed HD automatic overdrive ZF 6-speed HD manual overdrive ³ Allison 5-speed automatic overdrive ³	(2WD) 4108 (4x4) 3783	Vortec 6000 V8	300 @ 4400	360 @ 4000	Vortec 8100 V8 Duramax Diesel 6600 V8 ⁴
			3500 (1-ton)	2WD 4x4	133.0	222.2	11,400	5-speed HD manual overdrive	Hydra-matic 4-speed HD automatic overdrive ZF 6-speed HD manual overdrive ³ Allison 5-speed automatic overdrive ³	(2WD) 5864 (4x4) 5600	Vortec 6000 V8	300 @ 4400	360 @ 4000	Vortec 8100 V8 Duramax Diesel 6600 V8 ⁴
	Extended Cab Fleetside Short Box	Base, LS, LT	2500HD (3/4-ton)	2WD 4x4	143.5	227.6	9200	5-speed HD manual overdrive	Hydra-matic 4-speed HD automatic overdrive ZF 6-speed HD manual overdrive ³ Allison 5-speed automatic overdrive ³	(2WD) 3595 (4x4) 3152	Vortec 6000 V8	300 @ 4400	360 @ 4000	Vortec 8100 V8 Duramax Diesel 6600 V8 ⁴
			3500 (1-ton)	2WD 4x4	143.5	227.6	11,400	5-speed HD manual overdrive	Hydra-matic 4-speed HD automatic overdrive ZF 6-speed HD manual overdrive ³ Allison 5-speed automatic overdrive ³	(2WD) 3704 (4x4) 3153	Vortec 6000 V8	300 @ 4400	360 @ 4000	Vortec 8100 V8 Duramax Diesel 6600 V8 ⁴
	Extended Cab Fleetside Long Box	Base, LS, LT	2500HD (3/4-ton)	2WD 4x4	157.5	246.7	9200	5-speed HD manual overdrive	Hydra-matic 4-speed HD automatic overdrive ZF 6-speed HD manual overdrive ³ Allison 5-speed automatic overdrive ³	(2WD) 3704 (4x4) 3153	Vortec 6000 V8	300 @ 4400	360 @ 4000	Vortec 8100 V8 Duramax Diesel 6600 V8 ⁴
			3500 (1-ton)	2WD 4x4	157.5	246.7	11,400	5-speed HD manual overdrive	Hydra-matic 4-speed HD automatic overdrive ZF 6-speed HD manual overdrive ³ Allison 5-speed automatic overdrive ³	(2WD) 5508 (4x4) 5220	Vortec 6000 V8	300 @ 4400	360 @ 4000	Vortec 8100 V8 Duramax Diesel 6600 V8 ⁴
	Crew Cab Fleetside Short Box	Base, LS, LT	2500HD (3/4-ton)	2WD 4x4	153.0	237.3	9200	5-speed HD manual overdrive	Hydra-matic 4-speed HD automatic overdrive ZF 6-speed HD manual overdrive ³ Allison 5-speed automatic overdrive ³	(2WD) 3595 (4x4) 3303	Vortec 6000 V8	300 @ 4400	360 @ 4000	Vortec 8100 V8 Duramax Diesel 6600 V8 ⁴
			3500 (1-ton)	2WD 4x4	153.0	237.3	11,400	5-speed HD manual overdrive	Hydra-matic 4-speed HD automatic overdrive ZF 6-speed HD manual overdrive ³ Allison 5-speed automatic overdrive ³	(2WD) 3444 (4x4) 3153	Vortec 6000 V8	300 @ 4400	360 @ 4000	Vortec 8100 V8 Duramax Diesel 6600 V8 ⁴
	Crew Cab Fleetside Long Box	Base, LS, LT	2500HD (3/4-ton)	2WD 4x4	167.0	256.2	9200	5-speed HD manual overdrive	Hydra-matic 4-speed HD automatic overdrive ZF 6-speed HD manual overdrive ³ Allison 5-speed automatic overdrive ³	(2WD) 3444 (4x4) 3153	Vortec 6000 V8	300 @ 4400	360 @ 4000	Vortec 8100 V8 Duramax Diesel 6600 V8 ⁴
			3500 (1-ton)	2WD 4x4	167.0	256.2	11,400	5-speed HD manual overdrive	Hydra-matic 4-speed HD automatic overdrive ZF 6-speed HD manual overdrive ³ Allison 5-speed automatic overdrive ³	(2WD) 5306 (4x4) 5005	Vortec 6000 V8	300 @ 4400	360 @ 4000	Vortec 8100 V8 Duramax Diesel 6600 V8 ⁴

¹ Gross Vehicle Weight Rating (GVWR). When properly equipped; includes vehicle, passengers, cargo and equipment. ² Maximum payload capacity includes weight of driver, passengers, optional equipment and cargo. ³ Requires optional engine. ⁴ Limited availability. See your Chevrolet dealer for details.

To use the online model configurator, visit chevy.com/silveradobrochure

A
114.2" Regular Cab
138.7" Extended Cab
148.2" Crew Cab

B
133.0" Reg. Cab Long Box
143.5" Ext. Cab Short Box
157.5" Ext. Cab Long Box
153.0" Crew Cab Short Box
167.0" Crew Cab Long Box

C
222.2" Reg. Cab Long Box
227.6" Ext. Cab Short Box
246.7" Ext. Cab Long Box
237.3" Crew Cab Short Box
256.2" Crew Cab Long Box

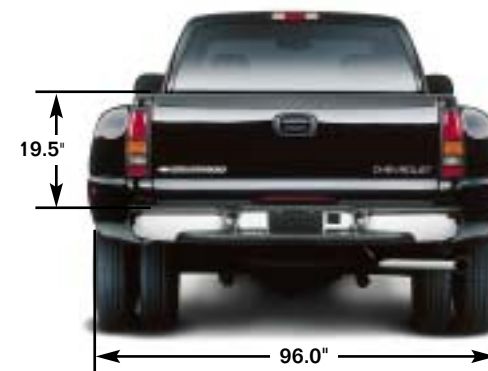
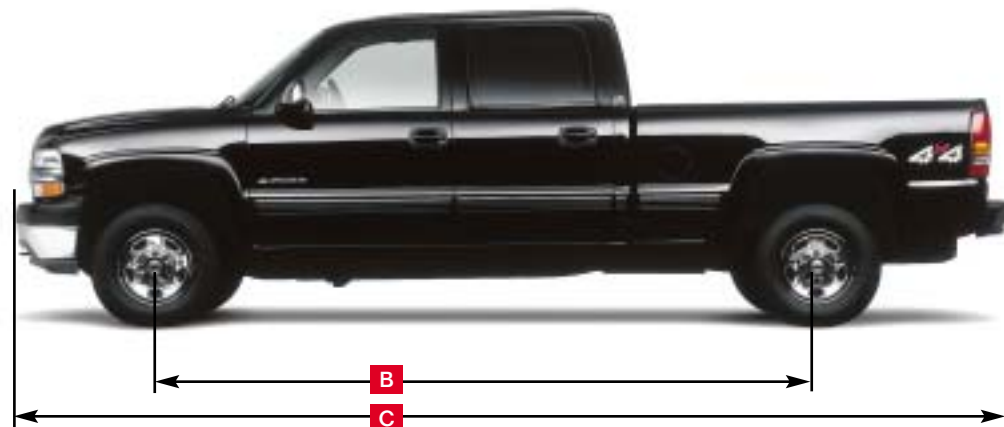
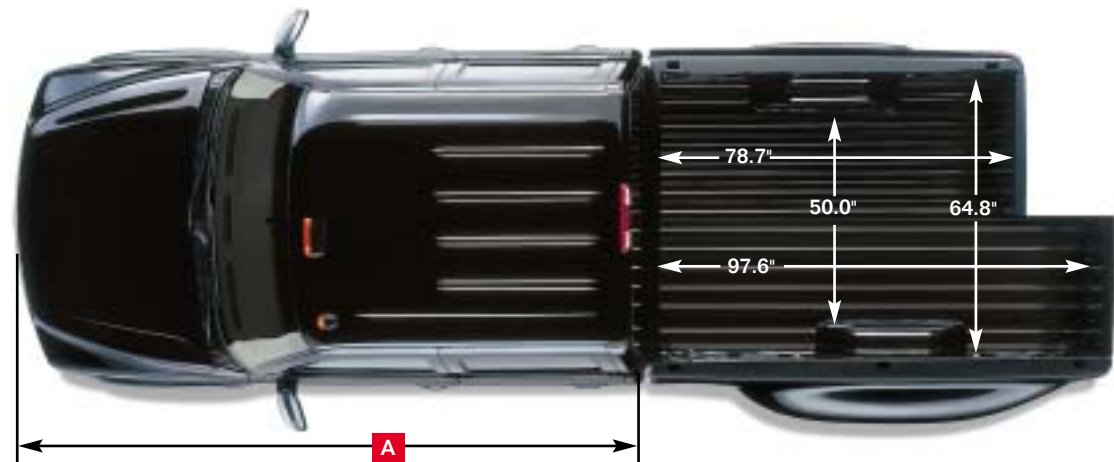

CHASSIS CAB MODELS

E
225.1" Reg. Cab
249.6" Reg. Cab
249.6" Ext. Cab
273.6" Ext. Cab

F
137.0" Reg. Cab
161.5" Reg. Cab
161.5" Ext. Cab
185.5" Ext. Cab

G
59.9" Reg. Cab
84.4" Reg. Cab
59.9" Ext. Cab
83.9" Ext. Cab

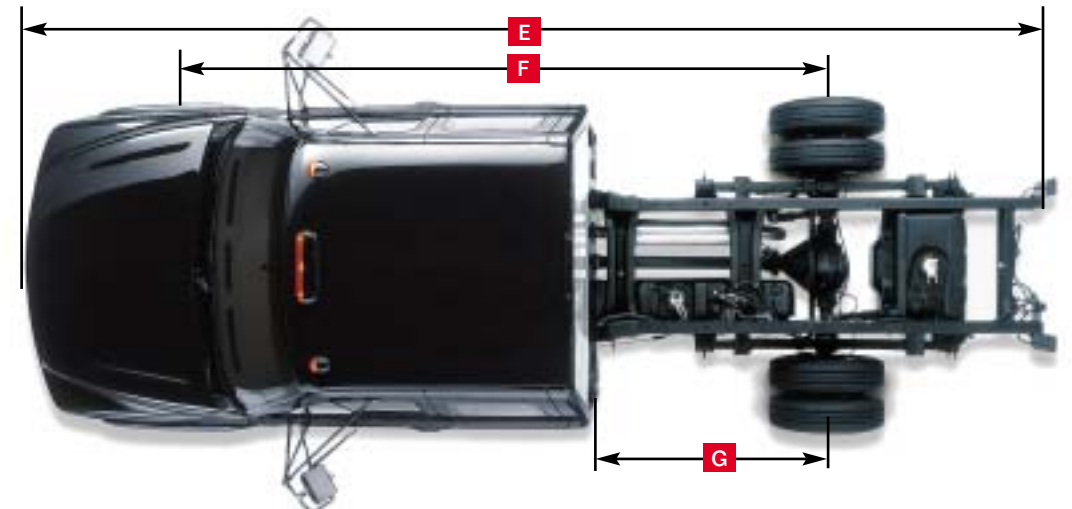

D
74.5" to 76.2"
depending on
series, model
and tire size
selected.

SEAT AND WHEEL CHOICES

BASE COLOR AVAILABILITY

EXTERIOR COLORS	INTERIOR COLORS	
	GRAPHITE	TAN
Onyx Black	■	■
Indigo Blue Metallic	■	■
Medium Charcoal Gray Metallic	■	■
Forest Green Metallic	■	■
Light Pewter Metallic	■	■
Victory Red	■	■
Summit White	■	■



Graphite Vinyl



Tan Cloth



Optional cloth 40/20/40 seat, shown in Graphite

LS COLOR AVAILABILITY

EXTERIOR COLORS	INTERIOR COLORS	
	GRAPHITE	TAN
Onyx Black*	■	■
Indigo Blue Metallic*	■	■
Medium Charcoal Gray Metallic	■	■
Forest Green Metallic	■	■
Light Pewter Metallic	■	■
Dark Carmine Red Metallic*	■	■
Victory Red*	■	■
Summit White*	■	■



Graphite Custom Leather*

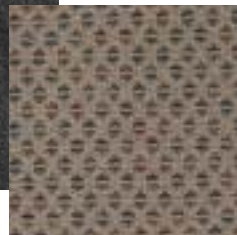

Tan Custom Cloth



LS Custom Cloth 40/20/40 seat, shown in Graphite

LT COLOR AVAILABILITY

EXTERIOR COLORS	INTERIOR COLORS		
	GRAPHITE	TAN	MED. GRAY
Onyx Black*	■	■	■
Indigo Blue Metallic*	■	■	■
Medium Charcoal Gray Metallic	■	■	■
Forest Green Metallic	■	■	■
Light Pewter Metallic	■	■	■
Dark Carmine Red Metallic*	■	■	■
Victory Red*	■	■	■
Summit White*	■	■	■



Graphite Custom Leather*

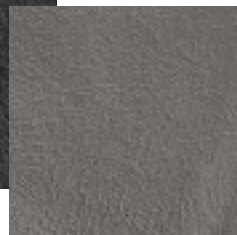

Medium Gray Custom Leather*



LT Custom Leather bucket seats,* shown in Tan

*Includes Dark Argent color-keyed body-side moldings. NOTE: Exterior colors on color-keyed body-side moldings except as noted.

*Not available in Regular Cab. Leather on seating surfaces only. Front seats only in Extended Cab models.



STEEL WHEELS. On 1500/2500/2500HD Base models, 16-inch silver-painted steel wheels with a chrome center cap are standard. 1500 six-lug wheel shown.



CHROME-STYLED STAINLESS-STEEL WHEELS. On 1500/2500/2500HD LS models, 16-inch wheels with chrome center cap are standard. Included in the optional Exterior Appearance Package. 1500 six-lug wheel shown.



CAST-ALUMINUM WHEELS. On 1500 LT models, 16-inch cast-aluminum wheels are standard. Optional on 1500 LS models.



FORGED-ALUMINUM WHEELS. On 1500HD/2500/2500HD LT models, 16-inch polished forged-aluminum wheels are standard. Optional on 1500HD/2500/2500HD LS models.



SILVER-PAINTED WHEELS. On LS and LT 3500 models, 16-inch silver-painted wheels are standard. Front wheel shown with chrome center cap and trim ring.

THE GM CARD® — WHAT ARE YOU CHARGING TOWARD?™
The GM Card rewards you 5% on every credit card purchase, making it the fastest way to save toward the GM car or truck of your dreams. For information or to apply for The GM Card, call **1-800-8GM-CARD** or visit our web site at www.gmcard.com

For more information about Silverado features, visit chevy.com/silveradobrochure

EXTERIOR FEATURES



Silverado 1500 Base 2WD Extended Cab Short Box shown in Summit White.



Silverado 1500 LS 2WD Extended Cab Short Box shown in Dark Carmine Red Metallic.



Silverado 1500 LT 4x4 Extended Cab Short Box shown in Light Pewter Metallic.

TRIM LEVEL	BASE	LS	LT
EXTERIOR FEATURES			
Body-side moldings with chrome accents	—	S	S
Chrome electric outside rearview mirrors	—	S	S
Camper-type retractable mirrors with wide field of vision	O	O	O
Chrome front bumper	S	S	S
Chrome rear step-bumper	O	S	S
Daytime Running Lamps with Automatic Exterior Lamp Control	S	S	S
Deluxe chrome grille (1500 and 2500 models)	O	S	S
Deluxe chrome grille (1500HD LS and LT, 2500HD and 3500 models)	S	S	S
Dual front recovery hooks (standard on 4x4 models)	O	O	O
Fog lamps	—	O	S
Heated outside rearview mirrors	—	O	S
Rear doors: driver- and passenger-side (Extended Cab and Crew Cab)	S	S	S
Sportside Box (1500 models)	O	O	O
Two-sided galvanized-steel body panels (except roof)	S	S	S
Underhood and cargo lamps	S	S	S
Wheel flares (available on 1500 2WD models; standard on all other models)	S	S	S
CHASSIS FEATURES			
Auxiliary battery ¹	O	O	O
Autotrac active transfer case (1500, 1500HD and 2500 4x4 models only) ²	—	O	S
Electric shift transfer case (2500HD and 3500 4x4 models only) ²	—	O	S
Engine-block heater	O	O	O
Engine oil cooler; external (except 1500 models)	S	S	S
Exhaust system: stainless-steel; aluminized stainless steel rear of converter	S	S	S
Four-wheel ABS disc brakes	S	S	S
Fuel capacities (approximate): Short Box models (26-gallon)	S	S	S
Long Box models (34-gallon)	S	S	S
Full-size spare tire and wheel with winch-type carrier and lock	S	S	S
Heavy-Duty Trailering Package: includes trailer hitch platform and seven-pin connector	O	O	O
High-capacity air cleaner	O	O	O
Locking differential; rear	O	O	O
Skid Plate Package (4x4 models): includes front differential and transfer case shields	O	O	O
Snow Plow Prep Package: ³ see your Chevy dealer for details	O	O	—
Traction Assist (1500 and 2500 2WD models)	O	O	O
Trailer wiring harness	S	S	S
Transmission: Hydra-matic four-speed automatic overdrive	O	O	S
SUSPENSION			
Heavy-Duty Suspension: (1500 and 2500 models)	O	O	O
Heavy-Duty Suspension: (1500HD LS and LT, 2500HD and 3500 models)	S	S	S
Off-Road (1500 4x4 models): includes 46mm shock absorbers; off-road jounce bumpers and stabilizer bars; Skid Plate Package; high-capacity air cleaner and Z71 decals	—	O	O
Ride Control (1500 models): ⁴ includes two-position (Smooth Road and Trailering) electronic control for shock absorber setting	—	O	O

S – Standard, O – Optional. **1** Not available on 1500 models or with California Emissions. **2** Requires automatic transmission. **3** Regular Cab 4x4 models only. **4** 4x4 models require Off-Road Suspension. **NOTE:** Tire chains should not be used on models equipped with P265/75R-16 tires because they could cause damage to these vehicles.

INTERIOR FEATURES

TRIM LEVEL	BASE	LS	LT
SEATING			
40/20/40 vinyl or cloth split-bench seat with recliners	S	—	—
Custom Cloth 40/20/40 split-bench seat with front recliners, manual lumbar support, fold-down center armrest with storage and mini overhead console with map lights	—	S	—
Reclining front bucket seats with six-way power: Custom Cloth or Custom Leather seating surfaces ¹ (rear vinyl on Extended Cab); includes extended floor and overhead console with map lights and multiple storage compartments	—	O	—
Reclining heated front bucket seats with Custom Leather seating surfaces, eight-way power, two-position driver-side memory, power recline, lumbar, thigh support, back bolster, extended floor and overhead console with map lights and multiple storage compartments	—	—	S
INTERIOR FEATURES			
Air conditioning	S	S	S
Carpeting with rubber floor mats	O	S	S
Delayed-entry lighting	—	S	S
Door handle-activated lighting	—	S	S
Driver and right front-passenger air bags with passenger Air Bag Off Switch ³	S	S	S
Dual covered power outlets	S	S	S
Electronic climate control (1500HD only)	—	—	O
OnStar ⁴	—	—	S
Power windows	—	S	S
Power door locks	O	S	S
Rear-seat heat ducts (Extended and Crew Cab)	S	S	S
Rear-window defogger	O	O	S
Self-dimming inside rearview mirror with eight-point compass	—	O	S
Solar-Ray light-tinted glass	S	S	—
Solar-Ray deep-tinted rear quarter and back glass	O	O	S
Sunshades with driver storage clip and passenger mirror	S	S	S
Swing-out quarter windows (Extended Cab)	S	S	S
INSTRUMENT PANEL FEATURES			
Cruise control	O	S	S
Driver Message Center	S	S	S
Full gauges with tachometer, trip odometer and engine hour meter	S	S	S
Intermittent windshield wipers	S	S	S
Leather-wrapped steering wheel	—	S	S
PASSlock theft-deterrent system	S	S	S
Remote Keyless Entry with content theft alarm	O	S	S
Tilt-Wheel steering column	S	S	S
SOUND SYSTEMS			
AM/FM stereo	S	—	—
AM/FM stereo with compact disc player, auto tone control	O	S	—
AM/FM stereo with cassette/compact disc players, auto tone control	—	O	S

S – Standard, O – Optional. **1** Custom Leather seating surfaces are not available on Regular Cab models. **2** Standard on 1500 models. **3** Always use safety belts and proper child restraints, even with air bags. Children are safer when properly secured in a rear seat. Air Bag Off Switch for use when carrying children. Air Bag Off Switch not included in Silverado Crew Cab models. See the Owner's Manual for more safety information. **4** One-year OnStar Safety and Security service contract is standard on Silverado LT. Call 1-800-ONSTAR-7 for system limitations and details.



Silverado 2500HD Base 4x4 Crew Cab Short Box shown in Summit White.



Silverado 3500 4x4 Crew Cab LS Long Box shown in Indigo Blue Metallic with additional features.



Silverado 2500HD 4x4 LT Crew Cab Short Box shown in Onyx Black.

EXTERIOR COLORS



Onyx Black



Dark Carmine Red Metallic



Medium Charcoal Gray Metallic



Victory Red



Light Pewter Metallic



Forest Green Metallic



Summit White



Indigo Blue Metallic

For more information on color availability for Silverado, visit chevy.com/silveradobrochure



Conventional Two-Tone (ZY2)

CHEVY TRUCKS LIKE A ROCK



Avalanche



Silverado



Suburban



Tahoe



TrailBlazer



Tracker



Blazer



S-10 Pickup



Astro



Express LT

▶ FOR ADDITIONAL INFORMATION ABOUT CHEVROLET VEHICLES, VISIT CHEVY.COM

AMERICA ONLINE KEYWORD: CHEVY

